

Colton, Ca (800) 949-9014  
 San Diego, Ca (866) 271-4402  
 Tracy, Ca (800) 366-1101



Sacramento, Ca (800) 375-6986  
 Phoenix, AZ (800) 729-1473  
 Las Vegas, NV (702) 649-1303

# SCRAPER PARTS

www.scrapersfloors.com

**Ejector Skins**

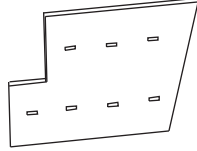

**Side Skins**

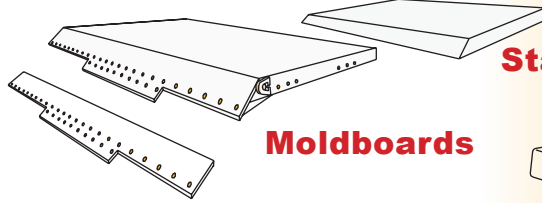

**Moldboards**

**Moving & Stationary Floors**



**Rear Ejector Channels**

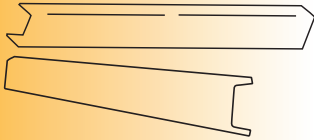

**Formed Bumper Channels**

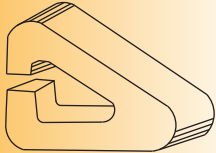
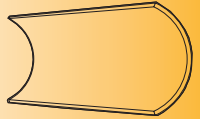

**Floor Locks**

**Stinger Plates**

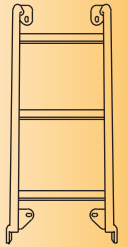

**Push Plates**

**Ladders**

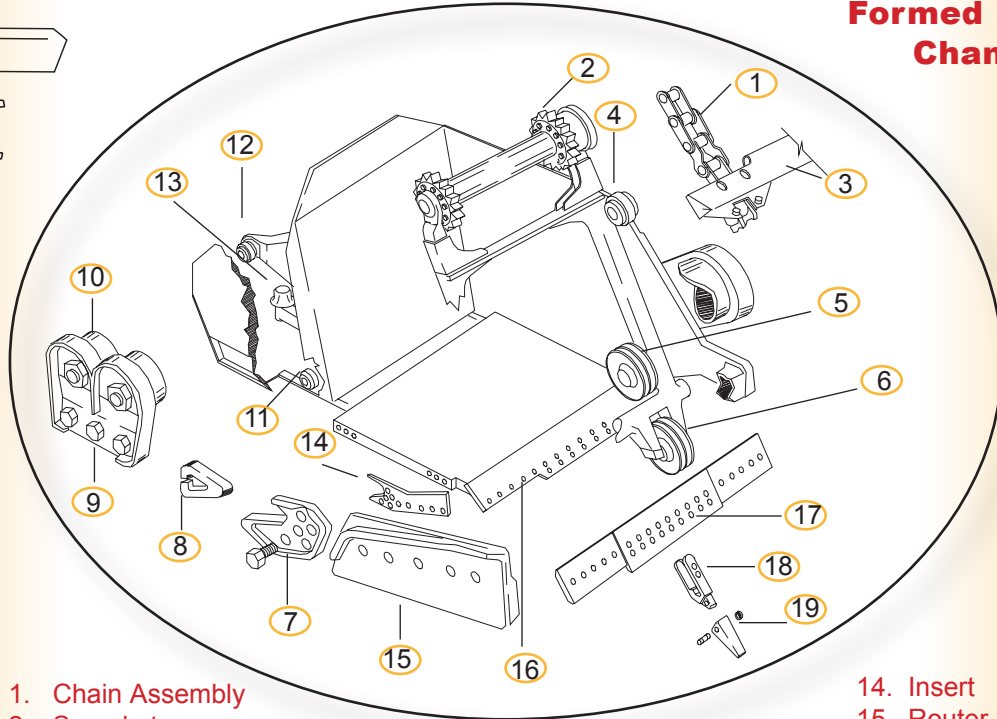
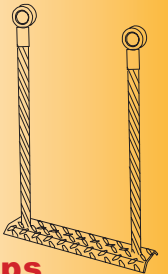

- 1. Chain Assembly
- 2. Sprocket
- 3. Flight
- 4. Upper Chain Roller Assembly
- 5. Center Idler Assembly

- 6. Bottom Idler Assembly
- 7. Floor Guide
- 8. Lock
- 9. Bracket-Roller Hanger
- 10, 11, 12 & 13 Roller

- 14. Insert
- 15. Router Bit
- 16. Moldboard
- 17. Blades
- 18. Adapter
- 19. Tooth

**Steps**

**Floor Guides**

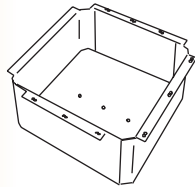
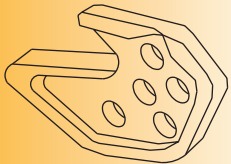

**Battery Boxes**

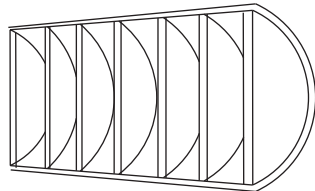

**Stinger Plate Assemblies**



**Moving Floor Rails**



**Side Ejector Rails**

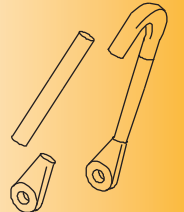

**Bail Repair Tubing**

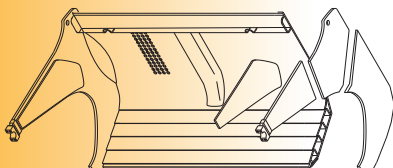

**Aprons, Apron Kits, Apron Arms  
1/4, 1/2 & Full**

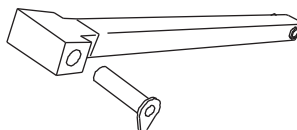

**Floor Links / Link Pins**



**Floor Hanger Brackets /  
Hanger Rollers**